

Hutmanschette Cup seal

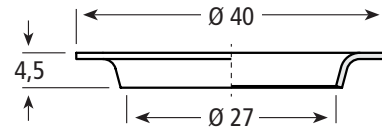

Artikel-Nr. / Part No.

410.0192

Material: PTFE compound

Farbe / Colour: ■

Abstreifer Wiper

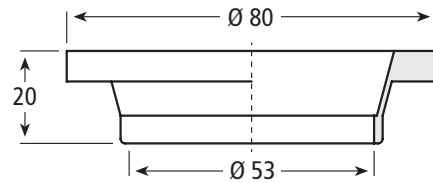

Artikel-Nr. / Part No.

410.0191

Material: PTFE

Farbe / Colour: □

Membrane Diaphragm

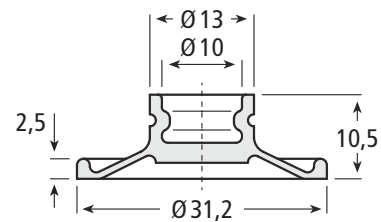

Artikel-Nr. / Part No.

106.0299

Material: EPDM, gewebeverstärkt / fabric reinforced

Farbe / Colour: ■

Membrane Diaphragm

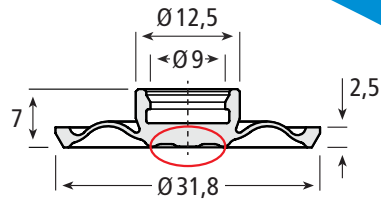

Artikel-Nr. / Part No.

106.0326 (Version A)

106.0326-1 (Version B)

Material: PTFE

Farbe / Colour:

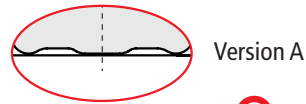

Version A

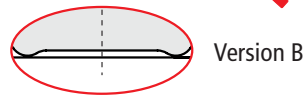

Version B

Membrane Diaphragm

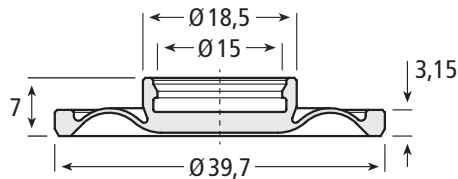

Artikel-Nr. / Part No.

106.0327

Material: PTFE

Farbe / Colour:

Membrane Diaphragm

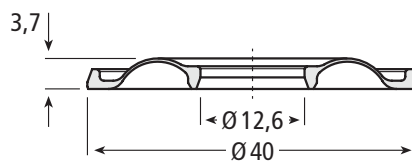

Artikel-Nr. / Part No.

106.0331

Material: PTFE

Farbe / Colour:

Membranen Diaphragms

Die von uns verwendeten Polyurethan- und Kautschuk-Elastomere zeichnen sich durch herausragende Eigenschaften aus:

- Ausgezeichneter mechanischer Verschleißwiderstand
- Niedriger Druckverformungsrest
- Hohe Thermostabilität
- Elastizität und Flexibilität
- Extreme Schnittfestigkeit
- Verschiedene Härtegrade

Weitere Abmessungen auf Anfrage möglich.

Our well-chosen polyurethane and rubber elastomers offer outstanding mechanical properties:

- Excellent resistance to mechanical wear
- Low compression set
- High thermostability
- Elasticity and flexibility
- Extreme cut-resistance
- Several hardness ranges

Further dimensions upon request.



Steuermembrane Diaphragm

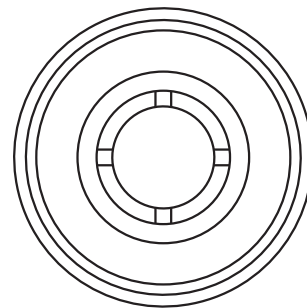
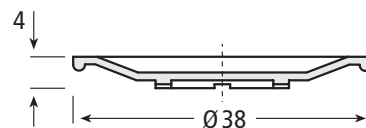

Artikel-Nr. / Part No.
106.0279

Material: EPDM, gewebeverstärkt / fabric reinforced
Farbe / Colour: ■

Trennmembrane Diaphragm

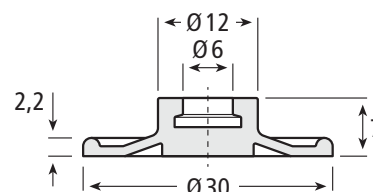

Artikel-Nr. / Part No.
106.0243

Material: EPDM, gewebeverstärkt / fabric reinforced
Farbe / Colour: ■

Membrane Diaphragm

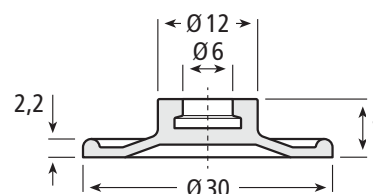

Artikel-Nr. / Part No.
106.0282

Material: EPDM, gewebeverstärkt / fabric reinforced
Farbe / Colour: ■

Kolben- und Stangendichtung mit Memory-Effekt

speziell für Aspetik-Anwendungen

Piston and rod seal with memory effect
especially for asptic applications

Dichtungen Gaskets

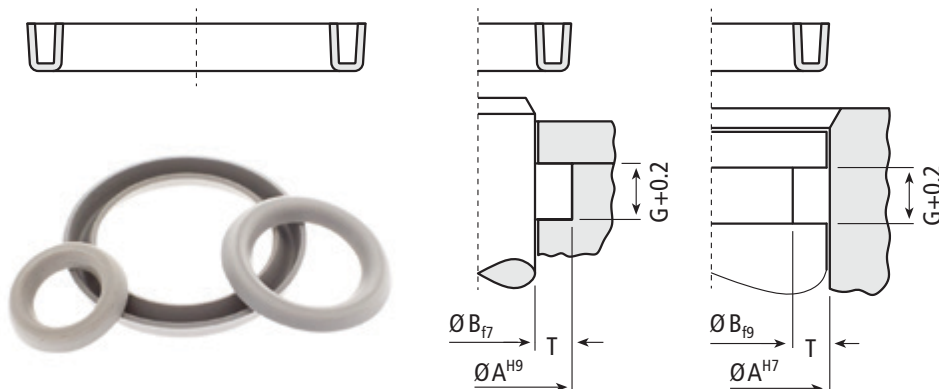

Artikel Nr. Part No.	Einbaumaße / Installation dimensions in mm			
	Bohrungs- / Zylinder-Ø Hole- / Cylinder-Ø	Stangen-Ø Rod-Ø	Nuttiefe Groove Depth	Nutbreite Groove Width
	A	B	T	G
411.0001-P	12	6	3	3,6
411.0002-P	13	7	3	3,6
411.0003-P	14	8	3	3,6
411.0004-P	16	10	3	3,6
411.0005-P	18	12	3	3,6
411.0006-P	20	14	3	3,6
411.0007-P	22	16	3	3,6
411.0008-P	24	18	3	3,6
411.0009-P	25	19	3	3,6
411.0010-P	26	20	3	3,6
411.0011-P	28	20	4	5,0
411.0012-P	30	22	4	5,0
411.0013-P	32	24	4	5,0
411.0014-P	33	25	4	5,0
411.0015-P	36	28	4	5,0
411.0016-P	38	30	4	5,0
411.0017-P	40	32	4	5,0
411.0018-P	44	36	4	5,0
411.0019-P	50	40	5	6,3
411.0020-P	55	45	5	6,3
411.0021-P	60	50	5	6,3
411.0022-P	63	53	5	6,3
411.0023-P	66	56	5	6,3
411.0024-P	70	60	5	6,3
411.0025-P	73	63	5	6,3
411.0026-P	80	70	5	6,3
411.0027-P	100	88	6	7,5

Material: PTFE compound
Farbe / Colour: ■

Unsere PTFE-Artikel, wie z.B. Faltenbälge, sind speziell für den Einsatz in der Lebensmittelindustrie konzipiert.

Vorteile:

- FDA-konformer Werkstoff
- Sehr gute Sterilisierbarkeit
- Universell chemikalienbeständig
- Hohe thermische Stabilität
– 60 °C bis +200 °C
- Höchste Biegewechsel-
festigkeit

Weitere Abmessungen
auf Anfrage möglich.

Our PTFE items, e.g. Bellows diaphragms, are specially designed for use in the food industry.

Benefits:

- FDA conformity
- Highly suitable for sterilization
- Universal chemical resistance
- High thermal stability
– 60 °C to +200 °C
(– 76 °F to +392 °F)
- Highest reverse bending strength

Further dimensions
upon request.



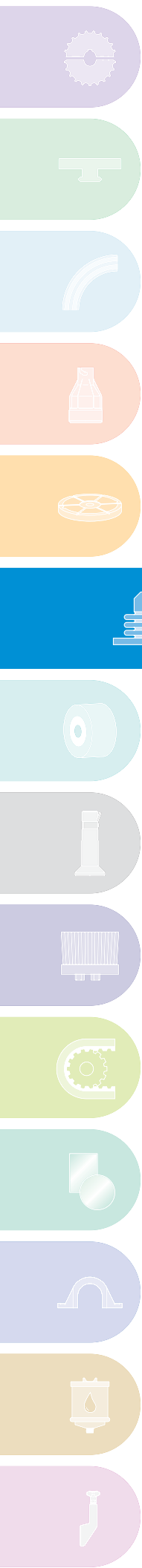

106.0060, 106.0061
106.0072, oder / or
106.0073

106.0299, 106.0326
oder / or 106.0327

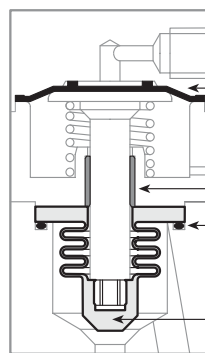
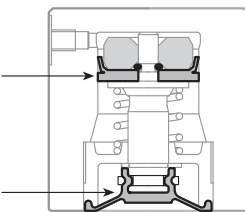

106.0279

410.0151

410.0179

106.0283

oder / or

106.0305

Ventilfaltenbalg, 3 Falten Bellows diaphragm, 3 bellows

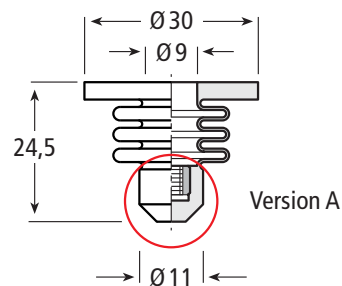

Version A

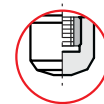

Version B

Artikel-Nr. / Part No.

106.0283 (Version A)

106.0305 (Version B)

Material: PTFE

Farbe / Colour:

Ventilfaltenbalg, 3 Falten Bellows diaphragm, 3 bellows

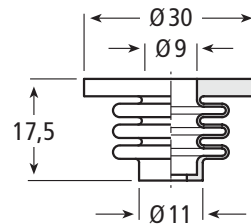

Artikel-Nr. / Part No.

106.0323

Material: PTFE

Farbe / Colour:

Ventilfaltenbalg, 4 Falten

Bellows diaphragm, 4 bellows

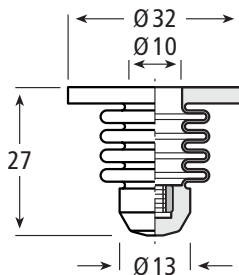

Artikel-Nr. / Part No.
106.0308

Material: PTFE
Farbe / Colour:

Ventilfaltenbalg, 6 Falten

Bellows diaphragm, 6 bellows

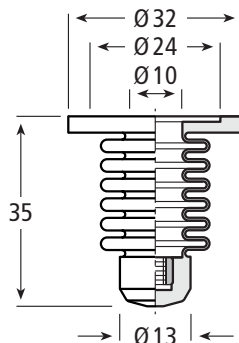

Artikel-Nr. / Part No.
106.0309

Material: PTFE
Farbe / Colour:

Teflonbalg, 12 Falten

Bellows diaphragm, 12 bellows

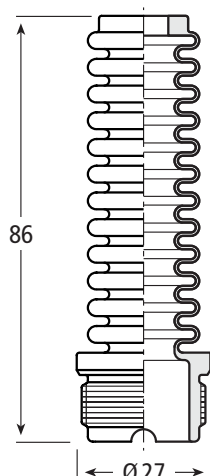

Artikel-Nr. / Part No.
106.0310

Material: PTFE
Farbe / Colour:

Faltenbälge

Bellows

Unsere PTFE-Artikel, wie z.B. Faltenbälge, sind speziell für den Einsatz in der Lebensmittelindustrie konzipiert.

Vorteile:

- FDA-konformer Werkstoff
- Sehr gute Sterilisierbarkeit
- Universell chemikalienbeständig
- Hohe thermische Stabilität
– 60 °C bis +200 °C
- Höchste Biegewechsel-
festigkeit

Weitere Abmessungen
auf Anfrage möglich.

Our PTFE items, e.g. Bellows diaphragms, are specially designed for use in the food industry.

Benefits:

- FDA conformity
- Highly suitable for sterilization
- Universal chemical resistance
- High thermal stability
– 60 °C to +200 °C
(– 76 °F to +392 °F)
- Highest reverse bending strength

Further dimensions
upon request.



Teflonbalg, 8 Falten

Bellows diaphragm, 8 bellows



Artikel-Nr. / Part No.
106.0321 (inkl. O-Ringe / incl. O-rings)
106.0284 (ohne O-Ringe / without O-rings)

Material: PTFE
 Farbe / Colour:

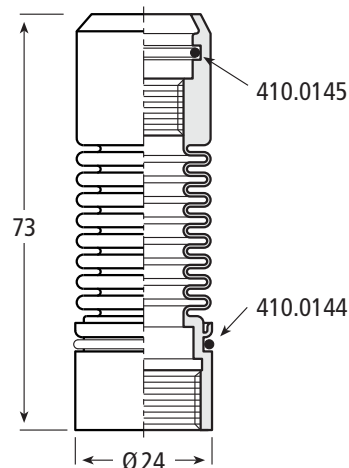

O-Ring

O-ring

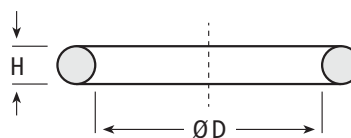

Artikel Nr. Part No.	Abmessungen / Dimensions in mm		Material	passend zu suitable to
	Ø D	H		
410.0145	16	2	EPDM	106.0284, 106.0317
410.0144	20,35	1,78	FPM	106.0284, 106.0317
410.0179	26	2	EPDM	106.0305, 106.0283

Farbe / Colour:

Faltenbalg, 9 Falten

Bellows diaphragm, 9 bellows



Artikel-Nr. / Part No.
106.0322 (inkl. O-Ringe / incl. O-rings)
106.0317 (ohne O-Ringe / without O-rings)

Material: PTFE
 Farbe / Colour:

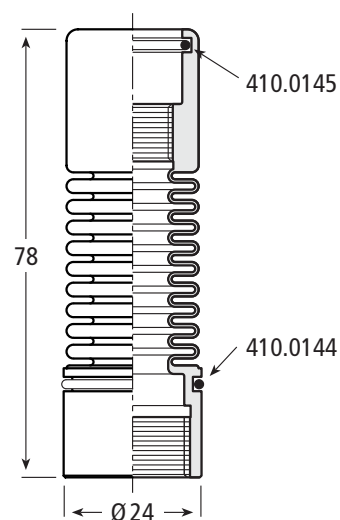

Faltenbalg, 10 Falten
Bellows diaphragm, 10 bellows

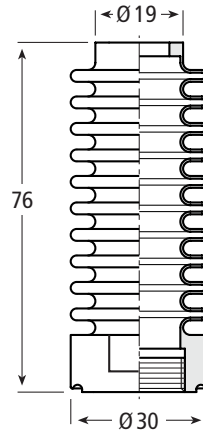

Artikel-Nr. / Part No.
106.0333

Material: PTFE
Farbe / Colour:

Faltenbalg, 18 Falten
Bellows diaphragm, 18 bellows

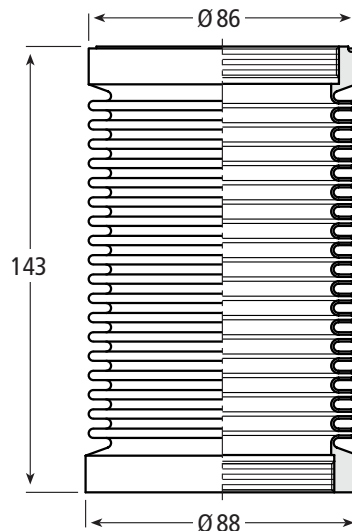

Artikel-Nr. / Part No.
106.0332

Material: PTFE
Farbe / Colour:

Faltenbalg, 6 Falten
Bellows diaphragm, 6 bellows

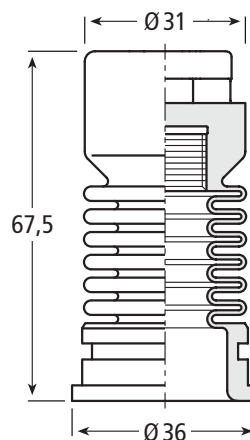

Artikel-Nr. / Part No.
106.0351

Material: PTFE
Farbe / Colour:

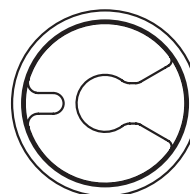

Faltenbälge
Bellows

Unsere PTFE-Artikel, wie z.B. Faltenbälge, sind speziell für den Einsatz in der Lebensmittelindustrie konzipiert.

Vorteile:

- FDA-konformer Werkstoff
- Sehr gute Sterilisierbarkeit
- Universell chemikalienbeständig
- Hohe thermische Stabilität
– 60 °C bis +200 °C
- Höchste Biegewechsel-
festigkeit

Weitere Abmessungen auf Anfrage möglich.

Our PTFE items, e.g. Bellows diaphragms, are specially designed for use in the food industry.

Benefits:

- FDA conformity
- Highly suitable for sterilization
- Universal chemical resistance
- High thermal stability
– 60 °C to +200 °C
(– 76 °F to +392 °F)
- Highest reverse bending strength

Further dimensions upon request.



Faltenbalg, JO®-Alternative in PTFE Bellows diaphragm, JO® alternative in PTFE

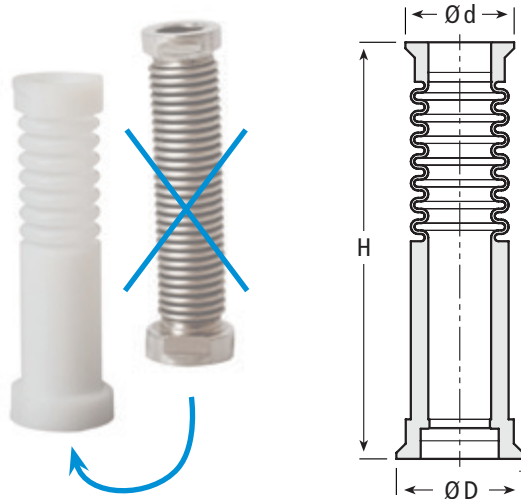

- Höhe kann abweichen - Einbaumaße/ Funktionalität identisch!
- Unsere JO®-Alternative in PTFE: exzellente Laufzeit und hervorragende chemische Beständigkeit
- Weniger Falten/Schmutzecken → bessere Hygiene
- Height can deviate - installation dimensions / functionality identical!
- Our JO® alternative in PTFE: excellent running time and outstanding chemical resistance
- Less bellows, fewer dirt corners → better hygiene

Artikel Nr. Part No.	Abmessungen Dimensions in mm			Falten Bellows
	H	Ø D	Ø d	
106.0352	69	21	18	7
106.0355	89	26	23,5	7
106.0358	82,5	26	23,5	7
106.0357	69	26	23,5	7

Material: PTFE Farbe / Colour:

Faltenbalg, 8 Falten Bellows diaphragm, 8 bellows

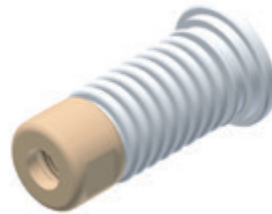

Artikel-Nr. / Part No.

106.0314

Material: PTFE, PTFE compound

Farbe / Colour:

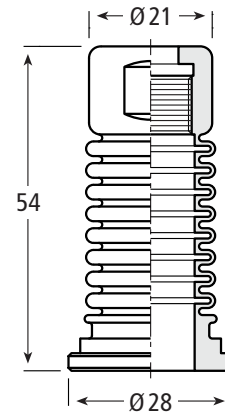

Faltenbalg, 14 Falten Bellows diaphragm, 14 bellows

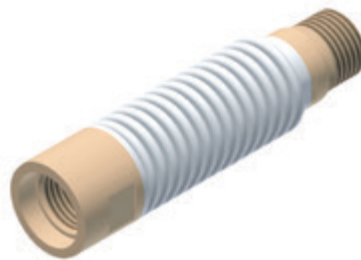

Artikel-Nr. / Part No.

106.0313

Material: PTFE, PTFE compound

Farbe / Colour:

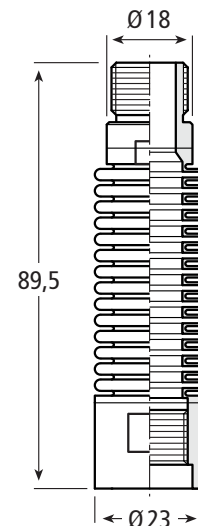

Faltenbalg, 14 Falten
Bellows diaphragm, 14 bellows

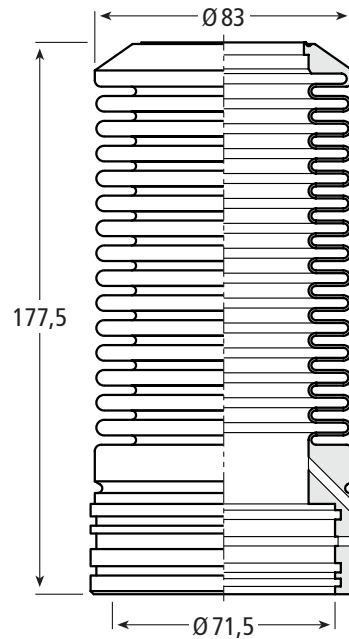

Artikel-Nr. / Part No.
106.0324

Material: PTFE
Farbe / Colour:

Faltenbalg, 7 Falten
Bellows diaphragm, 7 bellows

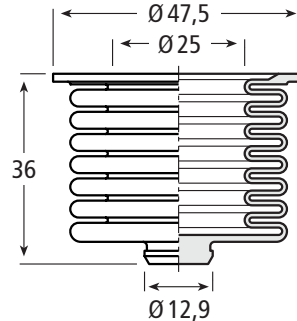

Artikel-Nr. / Part No.
106.0315

Material: PTFE
Farbe / Colour:

Faltenbalg, 9 Falten
Bellows diaphragm, 9 bellows

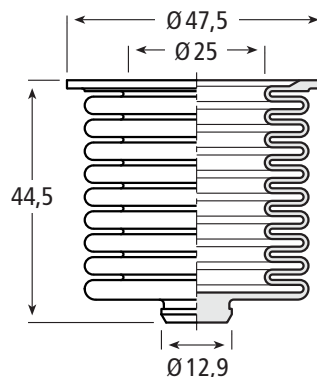

Artikel-Nr. / Part No.
106.0316

Material: PTFE
Farbe / Colour:

Faltenbälge
Bellows

Unsere PTFE-Artikel, wie z.B. Faltenbälge, sind speziell für den Einsatz in der Lebensmittelindustrie konzipiert.

Vorteile:

- FDA-konformer Werkstoff
- Sehr gute Sterilisierbarkeit
- Universell chemikalienbeständig
- Hohe thermische Stabilität
-60 °C bis +200 °C
- Höchste Biegewechsel-
festigkeit

Weitere Abmessungen
auf Anfrage möglich.

Our PTFE items, e.g. Bellows diaphragms, are specially designed for use in the food industry.

Benefits:

- FDA conformity
- Highly suitable for sterilization
- Universal chemical resistance
- High thermal stability
-60 °C to +200 °C
(-76 °F to +392 °F)
- Highest reverse bending strength

Further dimensions
upon request.



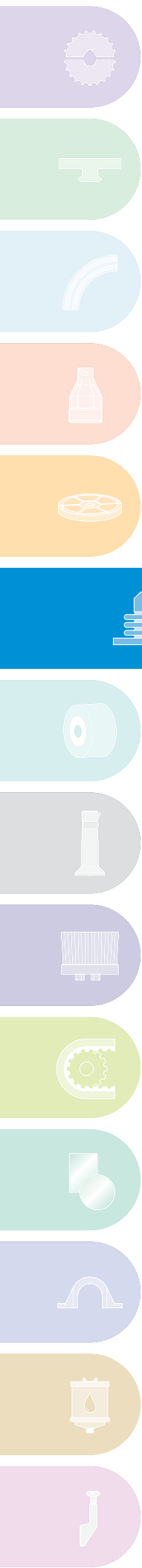

Faltenbalg, 7 Falten
Bellows diaphragm, 7 bellows

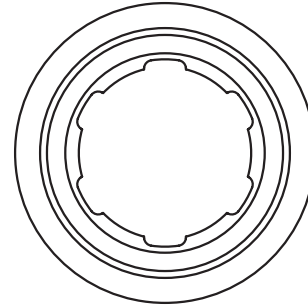
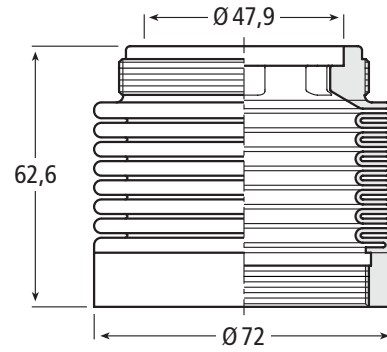

Artikel-Nr. / Part No.
106.0328

Material: PTFE, PTFE compound
Farbe / Colour:

Faltenbalg, 6 Falten
Bellows diaphragm, 6 bellows

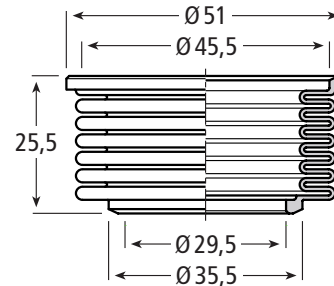

Artikel-Nr. / Part No.
106.0329

Material: PTFE
Farbe / Colour:

Faltenbalg, 7 Falten
Bellows diaphragm, 7 bellows

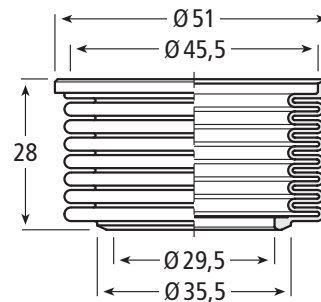

Artikel-Nr. / Part No.
106.0336

Material: PTFE
Farbe / Colour:

Faltenbalg, 6 Falten
Bellows diaphragm, 6 bellows

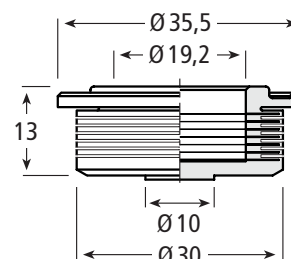

Artikel-Nr. / Part No.
106.0330

Material: PTFE
Farbe / Colour:

**Wellendichtring
Shaft seal**



**Dichtungen
Gaskets**

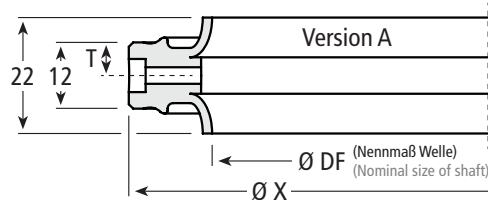

**Doppellippig
Double lipped**

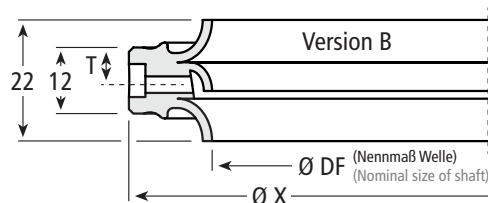

**Dreilippig
Triple lipped**

Unsere PTFE-Artikel, wie z.B. Faltenbälge, sind speziell für den Einsatz in der Lebensmittelindustrie konzipiert.

Vorteile:

- FDA-konformer Werkstoff
- Sehr gute Sterilisierbarkeit
- Universell chemikalienbeständig
- Hohe thermische Stabilität – 60 °C bis +200 °C
- Höchste Biegewechsel-
festigkeit

Weitere Abmessungen auf Anfrage möglich.

Our PTFE items, e.g. Bellows diaphragms, are specially designed for use in the food industry.

Benefits:

- FDA conformity
- Highly suitable for sterilization
- Universal chemical resistance
- High thermal stability – 60 °C to +200 °C (– 76 °F to +392 °F)
- Highest reverse bending strength

Further dimensions upon request.

Artikel Nr. Part No.	Abmessungen / Dimensions in mm			Version
	Ø DF	Ø X	T	
411.0039	95	125,2	6,75	A
411.0038	100	130,2	6,75	A
411.0040	120	150,2	6	A
411.0036	140	170,2	6	A
411.0037	140	170,2	6,75	A
411.0045	150	180,2	6,75	A
411.0041	180	210,2	6	A
411.0046	210	240,2	6,75	A
411.0042	220	250,2	6	A
411.0047	95	125,2	6,75	B
411.0048	100	130,2	6,75	B
411.0049	140	170,2	6,75	B
411.0050	150	180,2	6,75	B
411.0051	180	210,2	6,75	B
411.0052	210	240,2	6,75	B

Material: PTFE compound
Farbe / Colour: ■

Notizen / Notes

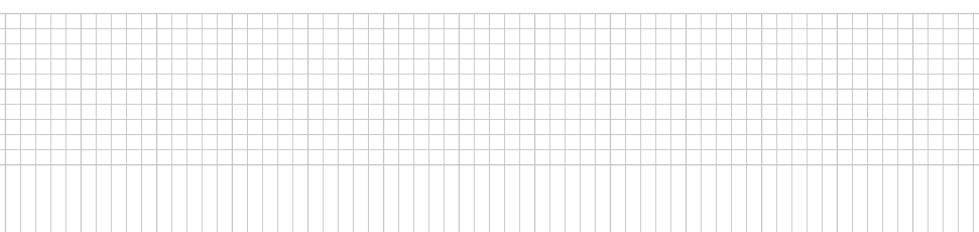

Topfmanschette mit einfacher oder doppelter Führung Cup packing with single or double guide

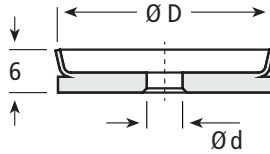

Artikel Nr. Part No.	Durchmesser / Diameter mm	
	D	d
106.0060	25	5
106.0072	25	7
106.0061	30	5
106.0073	30	7

Material: PTFE compound
Farbe / Colour: ■

Artikel Nr. Part No.	Durchmesser / Diameter mm	
	D	d
106.0091	25	7
106.0092	30	7

Material: PTFE compound
Farbe / Colour: ■

Ventilkegel Valve cone

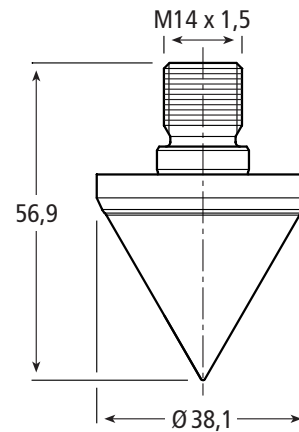

Artikel-Nr. / Part No.
106.0066

Material: PTFE
Farbe / Colour: □

Kolbenmembrane Piston diaphragm

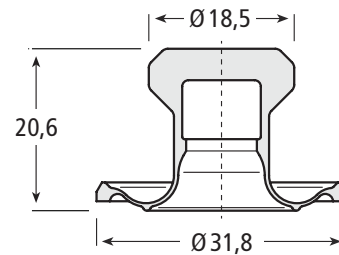

Artikel-Nr. / Part No.
106.0335

Material: PTFE
Farbe / Colour: □

Dichtkegel Seal Cone

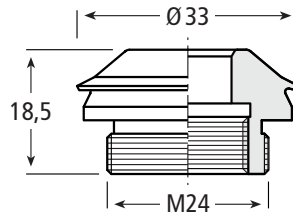

Artikel-Nr. / Part No.
106.0067

Material: PTFE
Farbe / Colour:

Dichtkegel Seal Cone

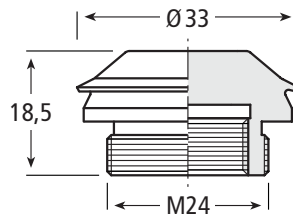

Artikel-Nr. / Part No.
106.0074

Material: PTFE
Farbe / Colour:

Dichtkegel Seal Cone

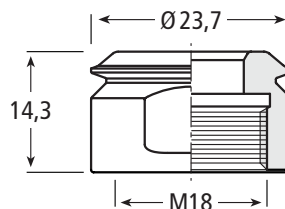

Artikel-Nr. / Part No.
106.0089

Material: PTFE
Farbe / Colour:

Dichtungen Gaskets

Unsere PTFE-Artikel, wie z.B. Faltenbälge, sind speziell für den Einsatz in der Lebensmittelindustrie konzipiert.

Vorteile:

- FDA-konformer Werkstoff
- Sehr gute Sterilisierbarkeit
- Universell chemikalienbeständig
- Hohe thermische Stabilität
– 60 °C bis +200 °C
- Höchste Biegewechsel-
festigkeit

Weitere Abmessungen
auf Anfrage möglich.

Our PTFE items, e.g. Bellows diaphragms, are specially designed for use in the food industry.

Benefits:

- FDA conformity
- Highly suitable for sterilization
- Universal chemical resistance
- High thermal stability
– 60 °C to +200 °C
(– 76 °F to +392 °F)
- Highest reverse bending strength

Further dimensions
upon request.

