

Flachsauger
Flat suction cup

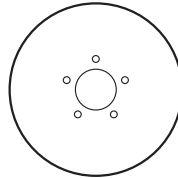
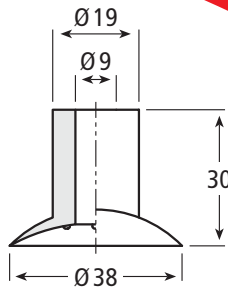

Artikel-Nr. / Part No.

111.0024

Material: Kautschuk-Elastomer / Rubber

Farbe / Colour: ■

Sauger
Suction cups

Die von uns verwendeten Werkstoffe, wie Vulkollan® oder Kautschuk-Elastomere zeichnen sich durch herausragende Eigenschaften aus:

- Elastizität und Flexibilität
- Ausgezeichneter mechanischer Verschleißwiderstand
- Hohe Adhäsion und Griffigkeit
- Hoher Weiterreißwiderstand
- Niedriger Druckverformungsrest

Our well-chosen materials such as Vulkollan® or rubber elastomers offer outstanding mechanical properties:

- Elasticity and flexibility
- Excellent resistance to mechanical wear
- High adhesion and grip
- Good tear propagation resistance
- Low compression set

Flachsauger
Flat suction cup

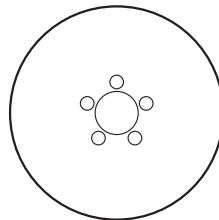
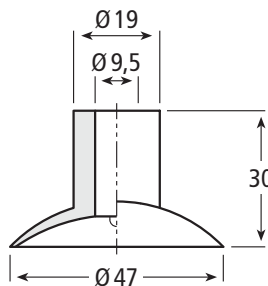

Artikel-Nr. / Part No.

111.0034

Material: Kautschuk-Elastomer / Rubber

Farbe / Colour: ■

Flachsauger
Flat suction cup

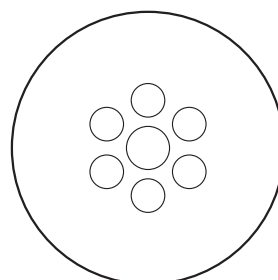
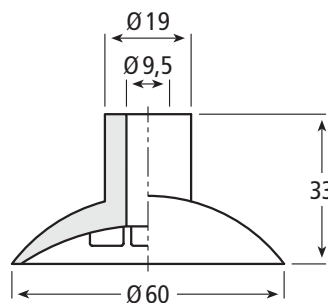

Artikel-Nr. / Part No.

111.0026

Material: Kautschuk-Elastomer / Rubber

Farbe / Colour: ■



Tellersauger, oval
Oval suction cup

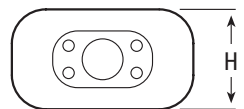
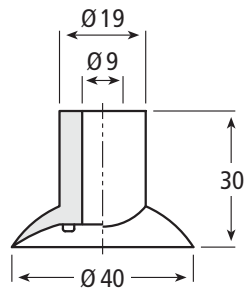

Artikel Nr. Part No.	Höhe / Height H in mm
111.0023	22
111.0040	30
Material: Kautschuk-Elastomer / Rubber	
Farbe / Colour: ■	

Flachsauger mit Drahtgewebe
Flat suction cup with wire sieve

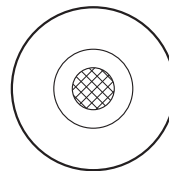
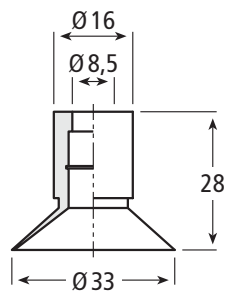

Artikel-Nr. / Part No.
111.0013

Material: PUR
Farbe / Colour: □

Flachsauger
Flat suction cup

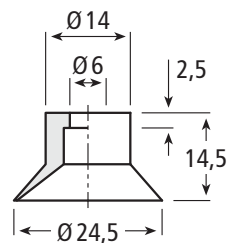

Artikel-Nr. / Part No.
111.0003

Material: massives, wasservernetztes,
gepresstes Vulkollan®
solid, watercrosslinked,
compression moulded Vulkollan®

Farbe / Colour: ■

Flachsauger Flat suction cup

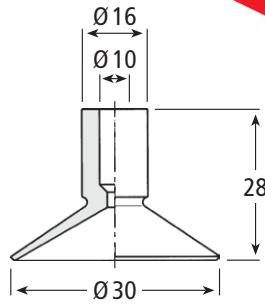

Artikel-Nr. / Part No.
111.0010

Material: Kautschuk-Elastomer / Rubber
Farbe / Colour: ■

Sauger Suction cups

Die von uns verwendeten Werkstoffe, wie Vulkollan® oder Kautschuk-Elastomere zeichnen sich durch herausragende Eigenschaften aus:

- Elastizität und Flexibilität
- Ausgezeichneter mechanischer Verschleißwiderstand
- Hohe Adhäsion und Griffbarkeit
- Hoher Weiterreißwiderstand
- Niedriger Druckverformungsrest

Our well-chosen materials such as Vulkollan® or rubber elastomers offer outstanding mechanical properties:

- Elasticity and flexibility
- Excellent resistance to mechanical wear
- High adhesion and grip
- Good tear propagation resistance
- Low compression set

Balgensauger Single bellows suction cup

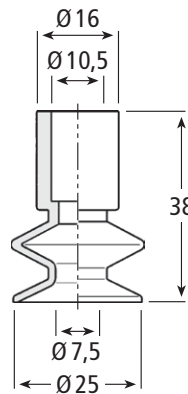

Artikel-Nr. / Part No.
111.0009

Material: Kautschuk-Elastomer / Rubber
Farbe / Colour: ■

Balgensauger mit 1/4" Innengewinde Single bellows suction cup with threaded bushing 1/4"

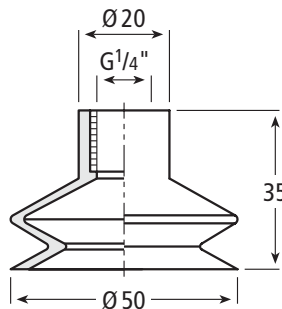

Artikel-Nr. / Part No.
111.0018

Material: Kautschuk-Elastomer / Rubber
Farbe / Colour: ■



