

Zentrierring
Lower part of centering tulip

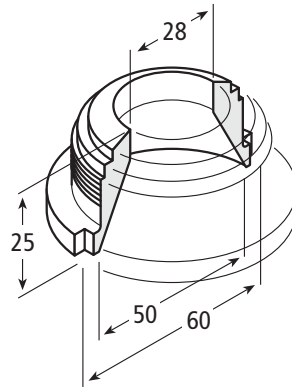

Artikel-Nr. / Part No.
106.0124-1

Material: verstärkter Kunststoff / reinforced plastic
Farbe / Colour: ■

Zentrierring
Lower part of centering tulip

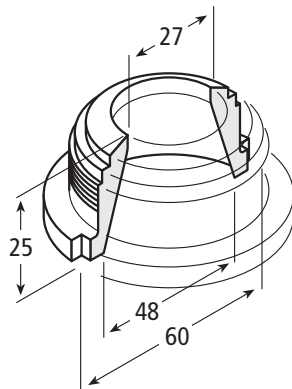

Artikel-Nr. / Part No.
106.0129

Material: verstärkter Kunststoff / reinforced plastic
Farbe / Colour: ■

Zentrierring
Lower part of centering tulip

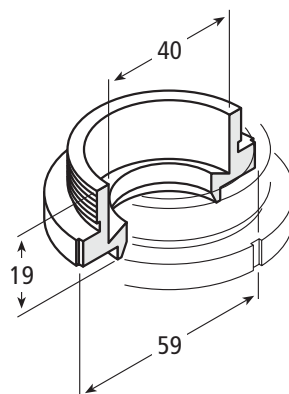

Artikel-Nr. / Part No.
106.0269

Material: verstärkter Kunststoff / reinforced plastic
Farbe / Colour: □

Zentriertulpen
Centering tulips

Unterschiedliche Anwendungen stellen unterschiedliche Anforderungen. Je nach Formteil verwenden wir Werkstoffe, die speziell für die abfüllenden & verpackenden Industrien geeignet sind, und sich auszeichnen durch:

- Hohe Verschleißfestigkeit
- Gute chemische Beständigkeit
- Ausgezeichnete Maßhaltigkeit und Oberflächenqualität

Weitere Formteile aus Kunststoff nach Zeichnung oder Muster.

Individual applications have different requirements. Depending on finished part we use materials which are especially suitable for the filling & packaging industries and stand out due to characteristic features such as:

- High abrasion resistance
- Good chemical resistance
- Excellent dimensional accuracy and surface quality

Further plastic finished parts according to drawings or samples.



Zentriertulpe DMR 28
Centering tulip DMR 28

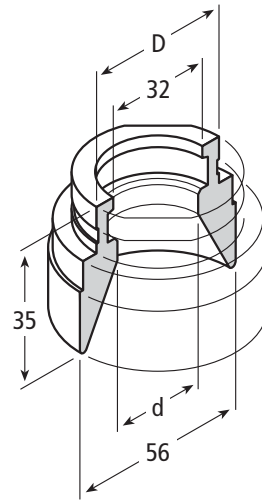

Artikel Nr. Part No.	Durchmesser / Diameter in mm	
	D	d
106.0176	44,5	29
106.0049	44	27,5

Material: verstärktes POM / reinforced POM
Farbe / Colour: ■

Zentriertulpe 28,5
Centering tulip 28.5

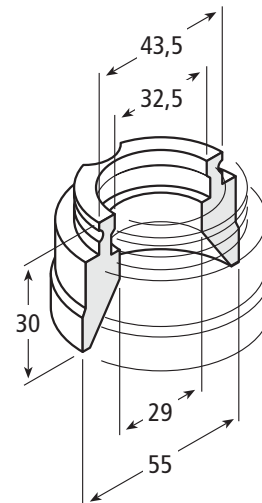

Artikel-Nr. / Part No.

106.0118

Material: verstärkter Kunststoff / reinforced plastic

Farbe / Colour: ■

Notizen / Notes



Zentriertulpen-Unterteil Tulip bottom

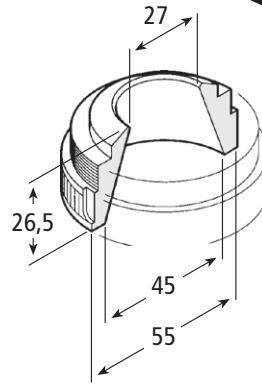

Artikel-Nr. / Part No.

106.0188-2

Material: verstärkter Kunststoff / reinforced plastic
Farbe / Colour: ■

Einsatz für Zentriertulpe Insert for centering tulip

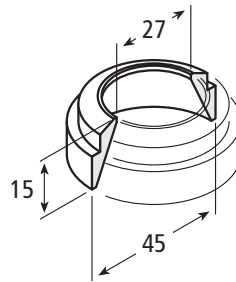

Artikel-Nr. / Part No.

106.0151

Material: verstärkter Kunststoff / reinforced plastic
Farbe / Colour: ■

Zentriertulpe Centering tulip

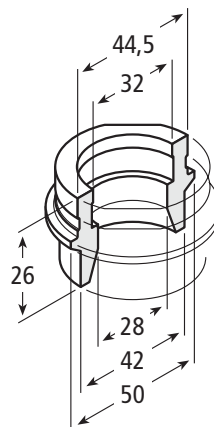

Artikel-Nr. / Part No.

106.0198

Material: verstärkter Kunststoff / reinforced plastic
Farbe / Colour: ■

Zentriertulpen Centering tulips

Unterschiedliche Anwendungen stellen unterschiedliche Anforderungen. Je nach Formteil verwenden wir Werkstoffe, die speziell für die abfüllenden & verpackenden Industrien geeignet sind, und sich auszeichnen durch:

- Hohe Verschleißfestigkeit
- Gute chemische Beständigkeit
- Ausgezeichnete Maßhaltigkeit und Oberflächenqualität

Weitere Formteile aus Kunststoff nach Zeichnung oder Muster.

Individual applications have different requirements. Depending on finished part we use materials which are especially suitable for the filling & packaging industries and stand out due to characteristic features such as:

- High abrasion resistance
- Good chemical resistance
- Excellent dimensional accuracy and surface quality

Further plastic finished parts according to drawings or samples.





Zentriertulpen-Oberteil Upper part of tulip

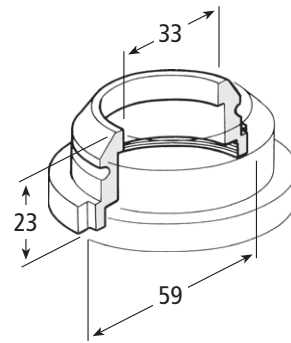

Artikel-Nr. / Part No.
106.0217-1

Material: verstärkter Kunststoff / reinforced plastic
Farbe / Colour: □

Zentriertulpen-Unterteil Tulip bottom

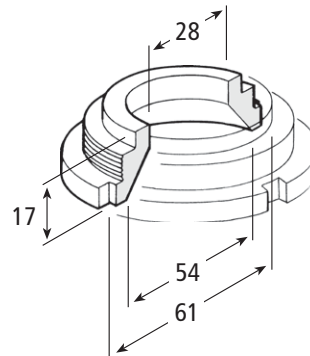

Artikel-Nr. / Part No.
106.0217-2

Material: verstärkter Kunststoff / reinforced plastic
Farbe / Colour: □

Zentrierring-Oberteil Upper part of centering tulip

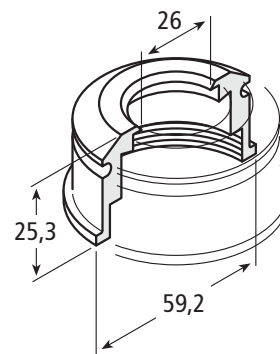

Artikel-Nr. / Part No.
106.0208-1

Material: verstärkter Kunststoff / reinforced plastic
Farbe / Colour: ■

Zentriereinsatz Tulip bottom

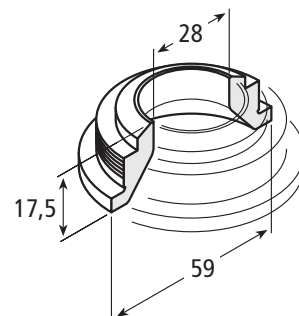

Artikel-Nr. / Part No.
106.0208-2

Material: verstärkter Kunststoff / reinforced plastic
Farbe / Colour: ■

Zentriertulpen-Einsatz Centering tulip insert



Artikel-Nr. / Part No.

106.0088

Material: verstärkter Kunststoff / reinforced plastic
Farbe / Colour: ■

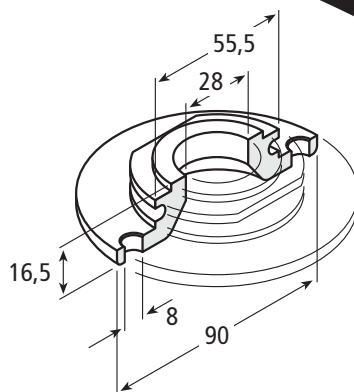

Zentriertulpen-Einsatz Centering tulip insert



Artikel-Nr. / Part No.

106.0226

Material: verstärkter Kunststoff / reinforced plastic
Farbe / Colour: ■

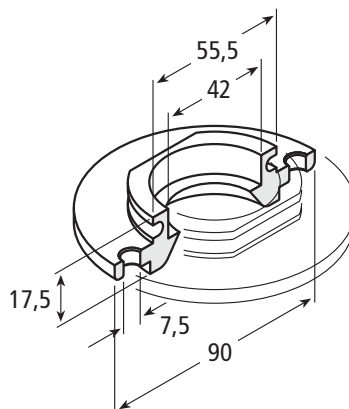

Tulpe 28 Tulip 28



Artikel-Nr. / Part No.

106.0084

Material: verstärkter Kunststoff / reinforced plastic
Farbe / Colour: □

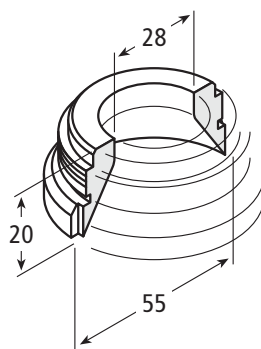

Tulpe 28,5 Tulip 28.5



Artikel-Nr. / Part No.

106.0085

Material: verstärkter Kunststoff / reinforced plastic
Farbe / Colour: □

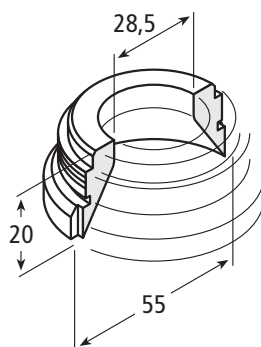

Zentriertulpen Centering tulips

Unterschiedliche Anwendungen stellen unterschiedliche Anforderungen. Je nach Formteil verwenden wir Werkstoffe, die speziell für die abfüllenden & verpackenden Industrien geeignet sind, und sich auszeichnen durch:

- Hohe Verschleißfestigkeit
- Gute chemische Beständigkeit
- Ausgezeichnete Maßhaltigkeit und Oberflächenqualität

Weitere Formteile aus Kunststoff nach Zeichnung oder Muster.

Individual applications have different requirements. Depending on finished part we use materials which are especially suitable for the filling & packaging industries and stand out due to characteristic features such as:

- High abrasion resistance
- Good chemical resistance
- Excellent dimensional accuracy and surface quality

Further plastic finished parts according to drawings or samples.





Mundstückaufnahme Centering tulip

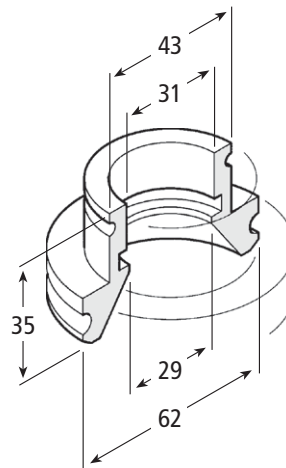

Artikel-Nr. / Part No.
106.0170

Material: verstärkter Kunststoff / reinforced plastic
Farbe / Colour: ■

Mundstückaufnahme Centering tulip

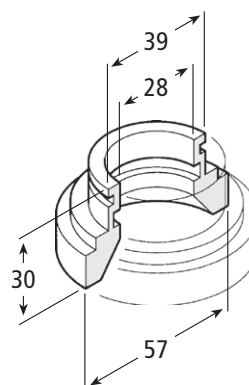

Artikel-Nr. / Part No.
106.0171

Material: verstärkter Kunststoff / reinforced plastic
Farbe / Colour: ■

Klemmring Clamp ring

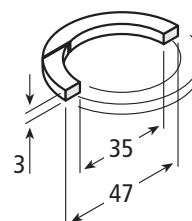

Artikel-Nr. / Part No.
106.0171-1

Material: verstärkter Kunststoff / reinforced plastic
Farbe / Colour: ■

Zentriertulpe TWO 43
Centering tulip TWO 43

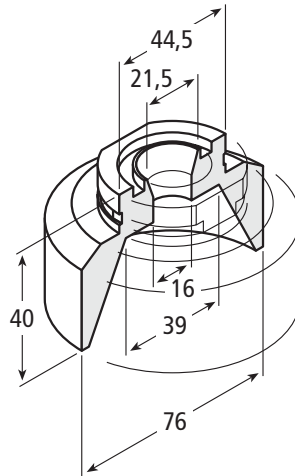

Artikel-Nr. / Part No.
106.0019

Material: verstärkter Kunststoff / reinforced plastic
Farbe / Colour: □

Zentriertulpe TWO 48/53
Centering tulip TWO 48/53

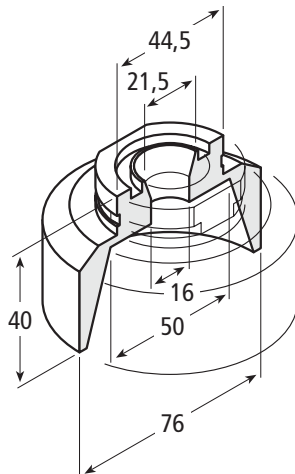

Artikel-Nr. / Part No.
106.0121

Material: verstärkter Kunststoff / reinforced plastic
Farbe / Colour: □

Zentriertulpe TWO 53
Centering tulip TWO 53

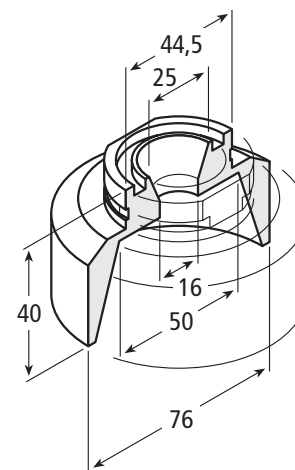

Artikel-Nr. / Part No.
106.0146

Material: verstärkter Kunststoff / reinforced plastic
Farbe / Colour: ■

Zentriertulpen
Centering tulips

Unterschiedliche Anwendungen stellen unterschiedliche Anforderungen. Je nach Formteil verwenden wir Werkstoffe, die speziell für die abfüllenden & verpackenden Industrien geeignet sind, und sich auszeichnen durch:

- Hohe Verschleißfestigkeit
- Gute chemische Beständigkeit
- Ausgezeichnete Maßhaltigkeit und Oberflächenqualität

Weitere Formteile aus Kunststoff nach Zeichnung oder Muster.

Individual applications have different requirements. Depending on finished part we use materials which are especially suitable for the filling & packaging industries and stand out due to characteristic features such as:

- High abrasion resistance
- Good chemical resistance
- Excellent dimensional accuracy and surface quality

Further plastic finished parts according to drawings or samples.

