

Manschette TR 50 Collar TR 50

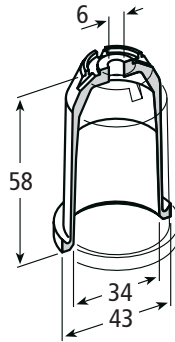

Artikel-Nr. / Part No.

101.0068-B

Material: gespritztes Polyurethan
injection moulded polyurethane

Farbe / Colour: ■

Manschette TR 58 Collar TR 58

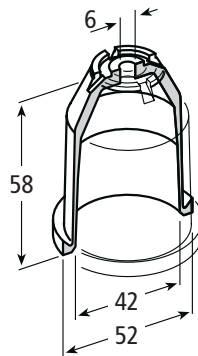

Artikel Nr. Part No.	Material	Farbe Colour	Ausführung Design
101.0049-PU	Polyurethan / Polyurethane	□	78° Sh. A
101.0049-PUB	Polyurethan / Polyurethane	■	86° Sh. A
101.0049-PUA	Vulkollan®	■	72° Sh. A
101.0049/1-PUA	Vulkollan®	■	mit Noppen / ribbed
101.0049/2-PUA	Vulkollan®	■	Bohrung / Bore 4,5 mm
101.0049-G	Gummi / Rubber	■	—
101.0049-GN	Gummi / Rubber	■	mit Noppen / ribbed
101.0049-GR	Gummi / Rubber	■	mit Rillen / with tread

Manschette TR 70 Collar TR 70

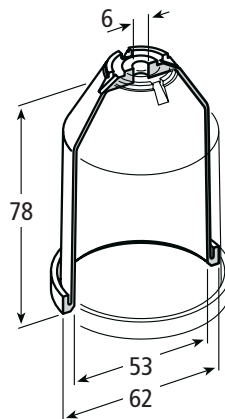

Artikel Nr. Part No.	Material	Farbe Colour	Ausführung Design
101.0050	Polyurethan / Polyurethane	■	86° Sh. A
101.0050-PUA	Vulkollan®	■	72° Sh. A
101.0050-GN	Gummi / Rubber	■	mit Noppen / ribbed

Packtulpen Tulip sleeves

Die von uns verwendeten Werkstoffe, wie Vulkollan®, Polyurethan- und Kautschuk-Elastomere zeichnen sich durch herausragende Eigenschaften aus:

- Ausgezeichneter mechanischer Verschleißwiderstand
- Hoher Weiterreißwiderstand
- Niedriger Druckverformungsrest
- Hohe Adhäsion und Griffigkeit
- Elastizität und Flexibilität

Our well-chosen materials such as Vulkollan®, polyurethane- and rubber-elastomers offer outstanding mechanical properties:

- Excellent resistance to mechanical wear
- Good tear propagation resistance
- Low compression set
- High adhesion and grip
- Elasticity and flexibility



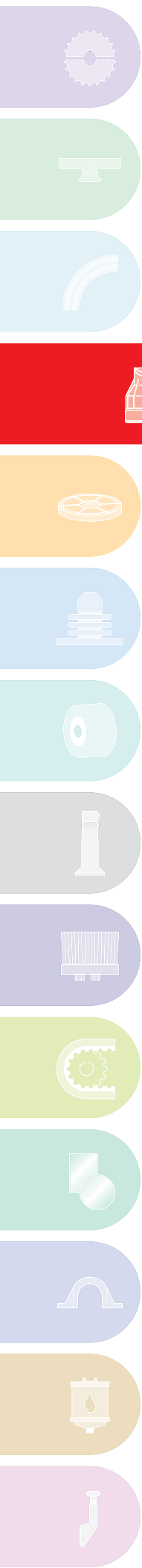

Packtulpe
Tulip sleeve

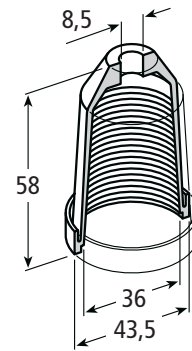

Artikel-Nr. / Part No.
101.0421

Material: gespritztes Polyurethan
injection moulded polyurethane

Farbe / Colour:

Packtulpe
Tulip sleeve

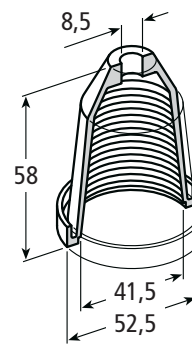

Artikel-Nr. / Part No.
101.0183

Material: gespritztes Polyurethan
injection moulded polyurethane

Farbe / Colour:

Packtulpe
Tulip sleeve

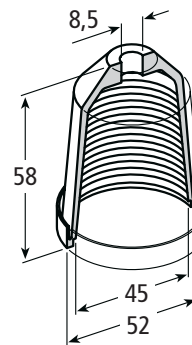

Artikel-Nr. / Part No.
101.0182

Material: gespritztes Polyurethan
injection moulded polyurethane

Farbe / Colour:

Packtulpe
Tulip sleeve

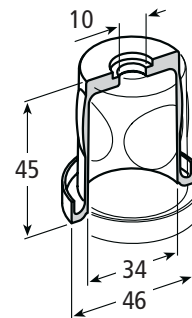

Artikel Nr. Part No.	Material	Farbe Colour
101.0057	Polyurethan / Polyurethane	<input type="checkbox"/>
101.0057-PUA	Vulkollan®	<input checked="" type="checkbox"/>
101.0057-G	Gummi / Rubber	<input checked="" type="checkbox"/>

Packtulpe
Tulip sleeve

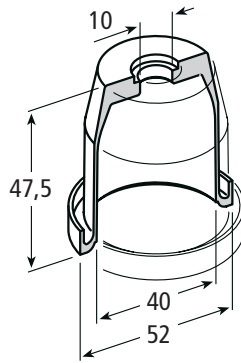

Artikel-Nr. / Part No.

101.0044

Material: gespritztes Polyurethan
injection moulded polyurethane

Farbe / Colour:

Packtulpe
Tulip sleeve

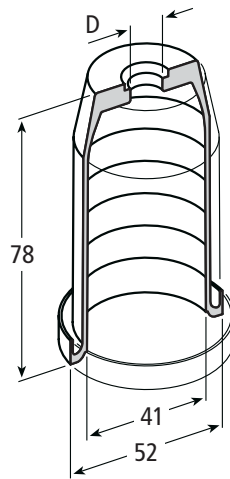

Artikel-Nr. / Part No.

101.0365 (D = 10 mm)

101.0365-24 (D = 24 mm)

Material: gespritztes Polyurethan
injection moulded polyurethane

Farbe / Colour:

Packtulpe
Tulip sleeve

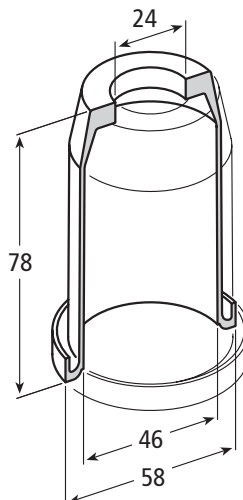

Artikel-Nr. / Part No.

101.0367

Material: gespritztes Polyurethan
injection moulded polyurethane

Farbe / Colour:

Packtulpen
Tulip sleeves

Die von uns verwendeten Werkstoffe, wie Vulkollan®, Polyurethan- und Kautschuk-Elastomere zeichnen sich durch herausragende Eigenschaften aus:

- Ausgezeichneter mechanischer Verschleißwiderstand
- Hoher Weiterreißwiderstand
- Niedriger Druckverformungsrest
- Hohe Adhäsion und Griffigkeit
- Elastizität und Flexibilität

Our well-chosen materials such as Vulkollan®, polyurethane- and rubber-elastomers offer outstanding mechanical properties:

- Excellent resistance to mechanical wear
- Good tear propagation resistance
- Low compression set
- High adhesion and grip
- Elasticity and flexibility



Packtulpe Tulip sleeve

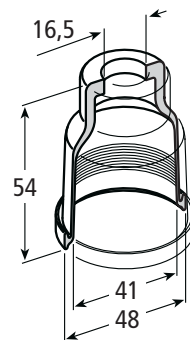

Artikel Nr. Part No.	Material	Farbe Colour
101.0045-PU	Polyurethan / Polyurethane	□
101.0045-G	Gummi / Rubber	■

Packtulpe Tulip sleeve

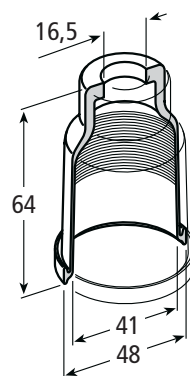

Artikel Nr. Part No.	Material	Farbe Colour
101.0046-PU	Polyurethan / Polyurethane	□
101.0046-G	Gummi / Rubber	■

Packtulpe Tulip sleeve

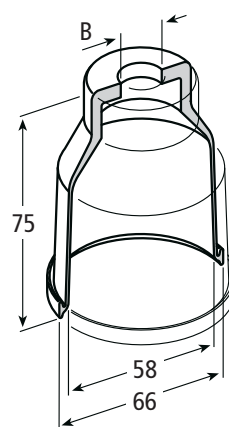

Artikel Nr. Part No.	Material	Farbe Colour	Härte Hardness	Bohrung Bore B (mm)
101.0067-PU	Polyurethan / Polyurethane	□	86° Sh.A	10,5
101.0067/1-PU	Polyurethan / Polyurethane	■	86° Sh.A	16,5
101.0067/1-75-PU	Polyurethan / Polyurethane	□	75° Sh.A	16,5
101.0067/1-G	Gummi / Rubber	■	—	16,5
101.0067/2-PU	Polyurethan / Polyurethane	□	75° Sh.A	26
101.0067/3-PU	Polyurethan / Polyurethane	□	75° Sh.A	24
101.0067/3B-PU	Polyurethan / Polyurethane	■	86° Sh.A	24

Packtulpe
Tulip sleeve

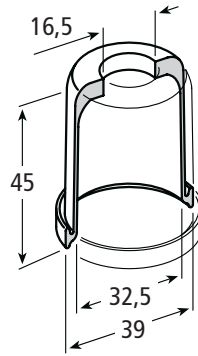

Artikel-Nr. / Part No.

101.0357

Material: gespritztes Polyurethan
injection moulded polyurethane

Farbe / Colour: □

Manschette R 50
Collar R 50

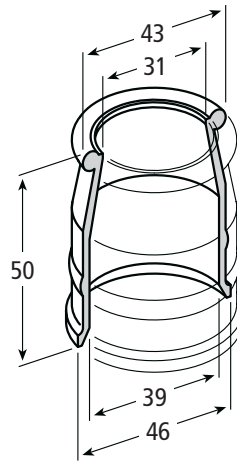

Artikel-Nr. / Part No.

101.0052-G

Material: Kautschuk-Elastomer
Rubber

Farbe / Colour: ■

Manschette R 58
Collar R 58

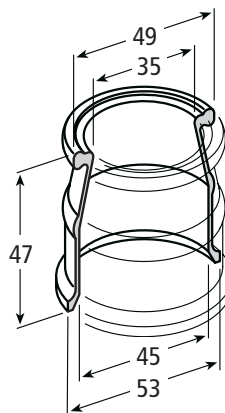

Packtulpen
Tulip sleeves

Die von uns verwendeten Werkstoffe, wie Vulkollan®, Polyurethan- und Kautschuk-Elastomere zeichnen sich durch herausragende Eigenschaften aus:

- Ausgezeichneter mechanischer Verschleißwiderstand
- Hoher Weiterreißwiderstand
- Niedriger Druckverformungsrest
- Hohe Adhäsion und Griffigkeit
- Elastizität und Flexibilität

Our well-chosen materials such as Vulkollan®, polyurethane- and rubber-elastomers offer outstanding mechanical properties:

- Excellent resistance to mechanical wear
- Good tear propagation resistance
- Low compression set
- High adhesion and grip
- Elasticity and flexibility

Artikel Nr. Part No.	Material	Farbe Colour	Ausführung Design
101.0051-PUA	Vulkollan®	■	—
101.0051-PUAR	Vulkollan®	■	mit Rillen / with tread
101.0051-G	Gummi / Rubber	■	—
101.0051-GN	Gummi / Rubber	■	mit Noppen / ribbed



Manschette R 47
Collar R 47

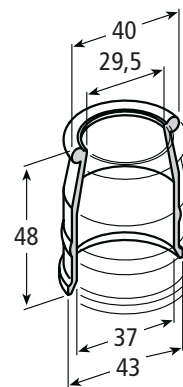

Artikel-Nr. / Part No.
101.0110

Material: Kautschuk-Elastomer / Rubber
Farbe / Colour: ■

Manschette R 62
Collar R 62

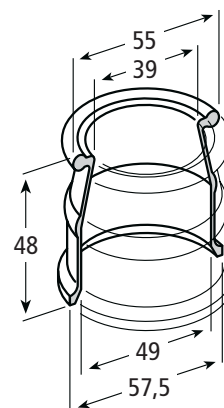

Artikel Nr. Part No.	Material	Farbe Colour	Ausführung Design
101.0054-PUA	Vulkollan®	■	—
101.0054	Gummi / Rubber	■	—
101.0054-GN	Gummi / Rubber	■	mit Noppen / ribbed

Manschette R 70
Collar R 70

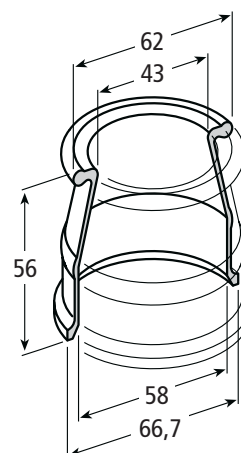

Artikel Nr. Part No.	Material	Farbe Colour	Ausführung Design
101.0077-PUA	Vulkollan®	■	—
101.0077-G	Gummi / Rubber	■	—
101.0077-GR	Gummi / Rubber	■	mit Rillen / with tread

Manschette R 72
Collar R 72

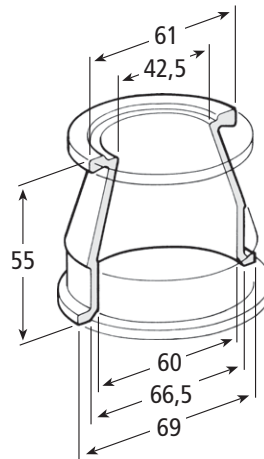

Artikel-Nr. / Part No.

101.0056

Material: Kautschuk-Elastomer
Rubber

Farbe / Colour: ■

Manschette R 82
Collar R 82

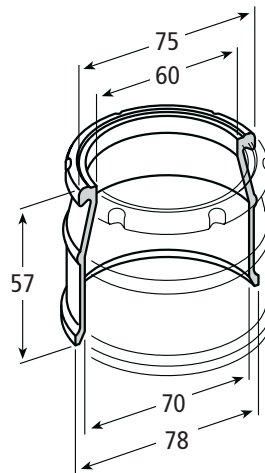

Artikel-Nr. / Part No.

101.0055

Material: Kautschuk-Elastomer
Rubber

Farbe / Colour: ■

Manschette R 87
Collar R 87

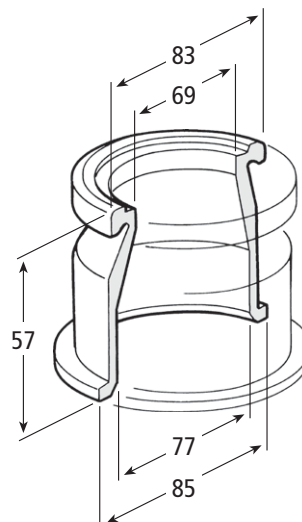

Artikel-Nr. / Part No.

101.0146-G

Material: Kautschuk-Elastomer
Rubber

Farbe / Colour: ■

Packtulpen

Tulip sleeves

Die von uns verwendeten Werkstoffe, wie Vulkollan®, Polyurethan- und Kautschuk-Elastomere zeichnen sich durch herausragende Eigenschaften aus:

- Ausgezeichneter mechanischer Verschleißwiderstand
- Hoher Weiterreißwiderstand
- Niedriger Druckverformungsrest
- Hohe Adhäsion und Griffigkeit
- Elastizität und Flexibilität

Our well-chosen materials such as Vulkollan®, polyurthane- and rubber-elastomers offer outstanding mechanical properties:

- Excellent resistance to mechanical wear
- Good tear propagation resistance
- Low compression set
- High adhesion and grip
- Elasticity and flexibility



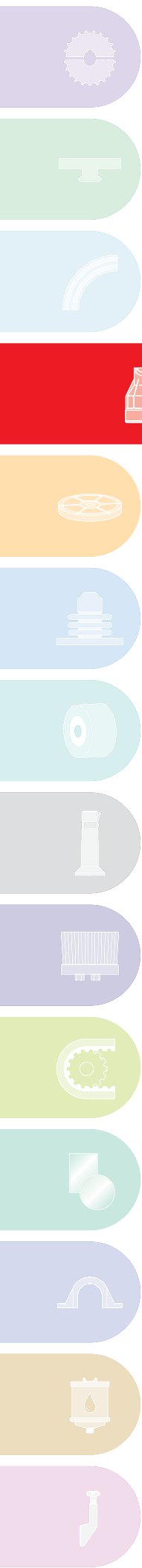

Packtulpe Tulip sleeve

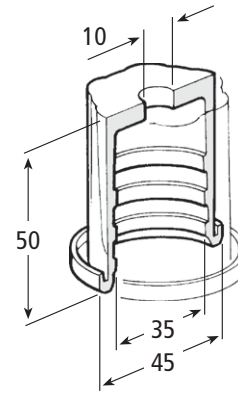

Artikel-Nr. / Part No.

101.0141-PUA

Material: massives, wasservernetztes,
gepresstes Vulkollan®
solid, watercrosslinked,
compression moulded Vulkollan®

Farbe / Colour: ■

Packtulpe Tulip sleeve

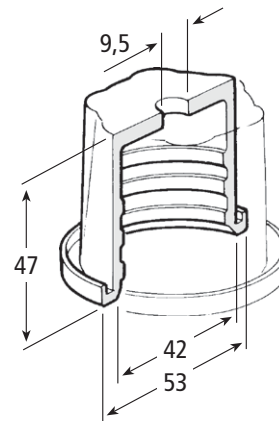

Artikel-Nr. / Part No.

101.0142-PUA

Material: massives, wasservernetztes,
gepresstes Vulkollan®
solid, watercrosslinked,
compression moulded Vulkollan®

Farbe / Colour: ■

Packtulpe Tulip sleeve

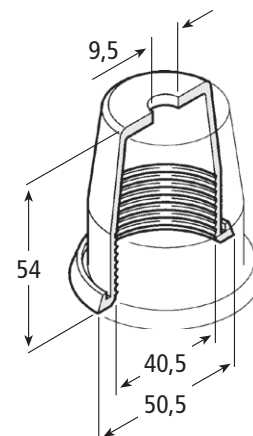

Artikel-Nr. / Part No.

101.0061-PUA

Material: massives, wasservernetztes,
gepresstes Vulkollan®
solid, watercrosslinked,
compression moulded Vulkollan®

Farbe / Colour: ■

Packtulpe
Tulip sleeve



Artikel-Nr. / Part No.
101.0060-G

Material: Kautschuk-Elastomer
Rubber
Farbe / Colour: ■

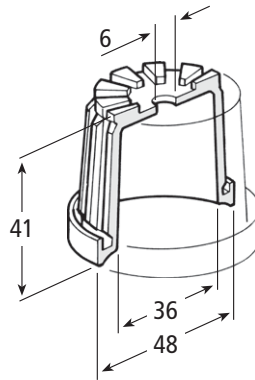

Packtulpe
Tulip sleeve



Artikel-Nr. / Part No.
101.0028-G

Material: Kautschuk-Elastomer / Rubber
Farbe / Colour: ■

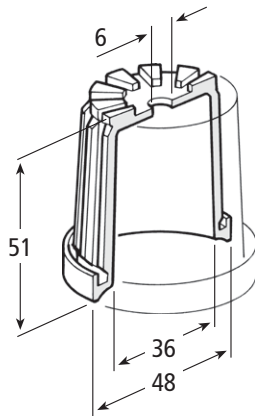

Packtulpe
Tulip sleeve

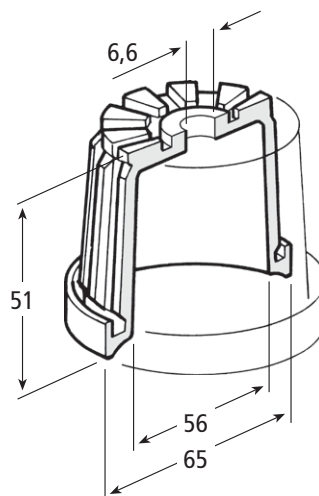

Packtulpen
Tulip sleeves

Die von uns verwendeten Werkstoffe, wie Vulkollan®, Polyurethan- und Kautschuk-Elastomere zeichnen sich durch herausragende Eigenschaften aus:

- Ausgezeichneter mechanischer Verschleißwiderstand
- Hoher Weiterreißwiderstand
- Niedriger Druckverformungsrest
- Hohe Adhäsion und Griffigkeit
- Elastizität und Flexibilität

Our well-chosen materials such as Vulkollan®, polyurthane- and rubber-elastomers offer outstanding mechanical properties:

- Excellent resistance to mechanical wear
- Good tear propagation resistance
- Low compression set
- High adhesion and grip
- Elasticity and flexibility

Artikel Nr. Part No.	Material	Farbe Colour	Ausführung Design
101.0231-G	Gummi / Rubber	■	—
101.0231-GR	Gummi / Rubber	■	mit Rillen / with tread



Packtulpe
Tulip sleeve

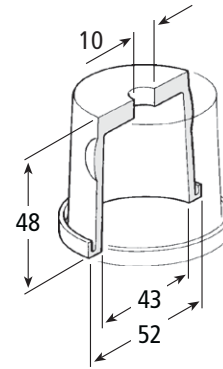

Artikel-Nr. / Part No.

101.0144-PUA

Material: massives, wasservernetztes,
gepresstes Vulkollan®
solid, watercrosslinked,
compression moulded Vulkollan®

Farbe / Colour: ■

Packtulpe
Tulip sleeve

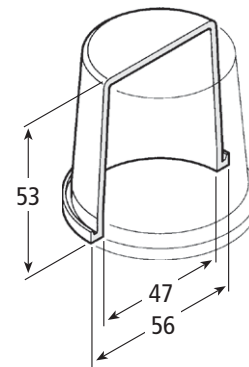

Artikel Nr. Part No.	Material	Farbe Colour
101.0059-PUA	Vulkollan®	■
101.0059-G	Gummi / Rubber	■

**Komponenten für
Greiferköpfe**
Pick-up head
components

Federspange
Spring clamp



Artikel-Nr. / Part No.

101.0016

Material: glasfaserverstärktes Polyamid
fibre-glass reinforced polyamide

Farbe / Colour: ■